

Data Sheet



Article number: 209925D50M16

Description: E+G Threaded end-caps - GN 992.5-D50-M16

Measures

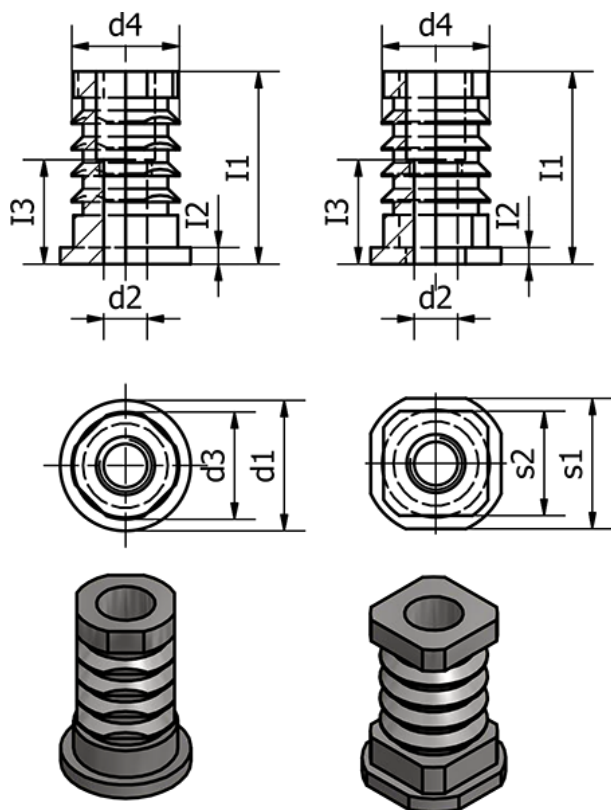

d1 = 50

d2 = M16

d3 = 44

d4 = 44.5

I1 = 37.5

I2 = 2.5

I3 = 30

s1 =

s2 =

Weight (g) = 200